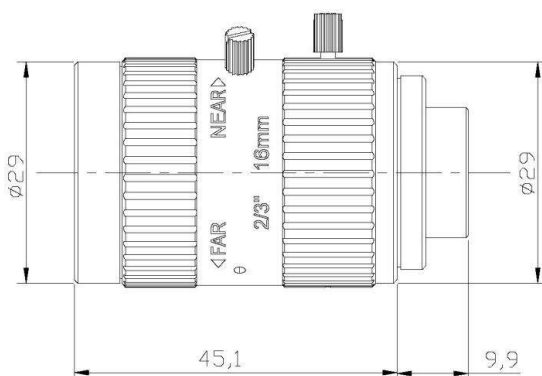

FEATURES

- ◆ Brand: ZLKC
- ◆ 2/3" C-Mount 16mm F2.8 10MP
- ◆ Design the high-resolution
- ◆ Can suppress stray light
- ◆ Low distortion, NIR Sensitivity
- ◆ Compact & Small volume

SPECIFICATION

10MP 16mm FA Lens C Mount		Working Distance	Magnification	2/3" Field of View (mm)		
Model	HMV-V1628MP10	mm	X	H	V	
Image Size	2/3-inch	1000	0.016X	532.24	442.39	
Focal length	16mm	900	0.018X	479.18	398.28	
F No.	F2.8-16	850	0.019X	453.04	376.56	
M.O.D(m)	0.15-Inf.	800	0.020X	426.58	354.56	
Operation	Iris	Manual	750	0.021X	400.27	332.69
	Focus	Manual	700	0.023X	373.82	310.71
Horizontal Angle of View (D×H×V)	2/3"	37.9°×30.8°×23.3°	650	0.025X	347.33	288.69
	1/2"	28.1°×22.6°×17.1°	600	0.027X	320.91	266.73
	1/3"	21.2°×17.0°×12.8°	550	0.029X	294.38	244.68
Distortion	-0.15%	500	0.032X	268.08	222.82	
BFL	8.63mm	450	0.036X	241.71	200.90	
Flange FL	17.526mm	400	0.040X	215.24	178.90	
Mount	C-Mount	350	0.046X	188.83	156.95	
Object Dimension	83.0mm×69.0mm(WD=150mm)	300	0.053X	162.39	134.97	
Dimension	Φ29×45.1mm	250	0.064X	136.03	113.06	
Weight	69.2g	200	0.080X	109.52	91.03	
Filter	M27 P=0.5mm	150	0.107X	83.08	69.05	
Working Temperature	-20°C ~ +60°C	100	0.160X	59.28	49.27	