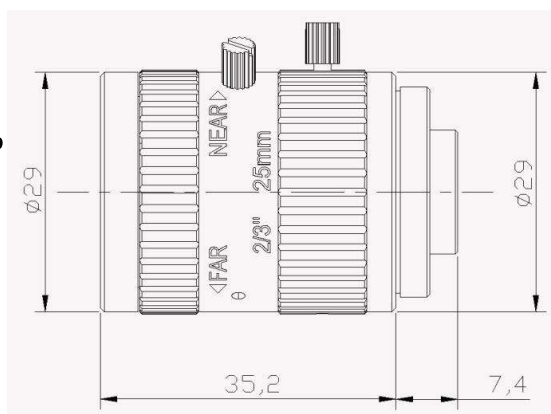

FEATURES

- ◆ Brand: ZLKC
- ◆ 2/3" C-Mount 25mm F2.8 10MP
- ◆ Design the high-resolution
- ◆ Can suppress stray light
- ◆ Low distortion, NIR Sensitivity
- ◆ Compact & Small volume

SPECIFICATION

10MP 25mm FA Lens C Mount		Working Distance	Magnification	2/3" Field of View (mm)		
Model	HMV-V2528MP10	mm	X	H	V	
Image Size	2/3-inch	1000	0.025X	333.01	276.79	
Focal length	25mm	900	0.028X	299.19	248.67	
F No.	F2.8-16	850	0.029X	282.26	234.60	
M.O.D(m)	0.15-Inf.	800	0.031X	265.35	220.55	
Operation	Iris	Manual	750	0.033X	248.42	206.48
	Focus	Manual	700	0.036X	231.49	192.41
Horizontal Angle of View (D×H×V)	2/3"	24.8°×19.9°×15.0°	650	0.038X	214.59	178.36
	1/2"	18.2°×14.6°×11.0°	600	0.042X	197.68	164.31
	1/3"	13.7°×10.9°×8.2°	550	0.045X	180.77	150.25
Distortion	-0.02%	500	0.050X	163.85	136.18	
BFL	10.31mm	450	0.056X	146.94	122.13	
Flange FL	17.526mm	400	0.063X	130.01	108.06	
Mount	C-Mount	350	0.071X	113.08	93.99	
Object Dimension	45.3mm×37.7mm(WD=150mm)	300	0.083X	96.17	79.93	
Dimension	Φ29×35.2mm	250	0.100X	79.25	65.87	
Weight	54.8g	200	0.125X	62.31	51.79	
Filter	M27 P=0.5mm	150	0.167X	45.38	37.72	
Working Temperature	-20°C ~ +60°C	100	0.250X	29.26	24.32	